

# Robot vacuum cleaner

---

## User Manual

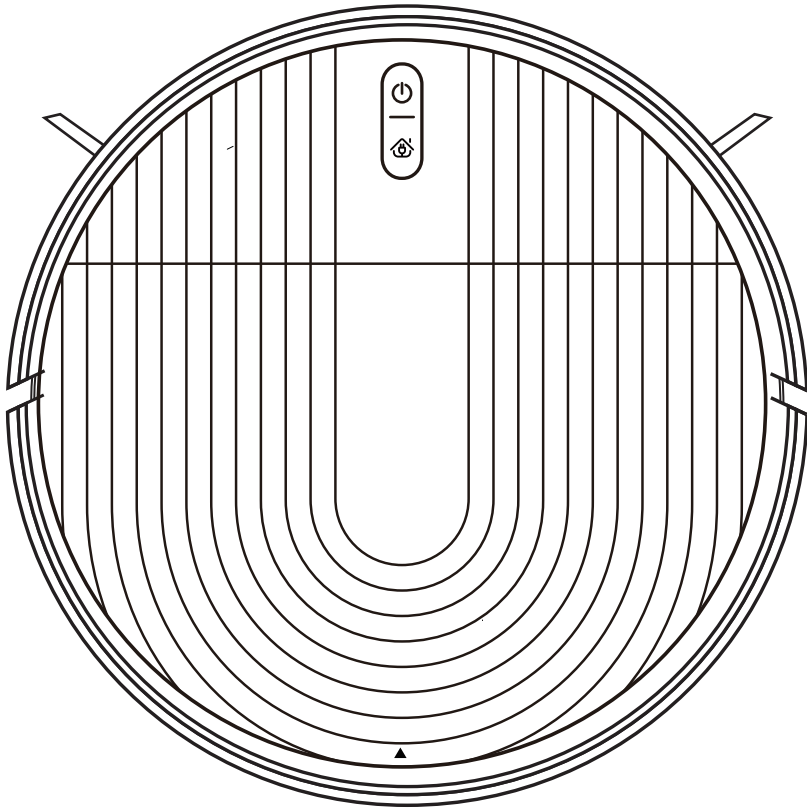

Thank you for choosing our smart vacuum cleaner!  
Please read this manual carefully before use.

## Contents

---

1.Safety Instructions	1
2.Precautions	2
3.Product Introduction	3
3.1 Cleaner Part Diagram	3
3.2 Specifications	5
4.Operation Instructions	6
4.1 Charging method and quick start guide	6
4.2 Remote controller	7
4.3 Set reservation	7
5.Maintenance	9
5.1 Dust collector and filter screen cleaning	9
5.2 Clean the side brush and universal caster	9
5.3 Clean the cliff sensor	9
5.4 Clean the charging electrode	9
5.5 Clean the suction port	9
5.6 Clean the sensor window	9
5.7 Installation of the water tank(some model with this function)	10
6.Trouble Shooting	11
7.Packing List	12

# 1.Safety Instructions

---

Please follow the following safety precautions before using the product:

- Please read this manual carefully before using the product and use the product according to the instructions in this manual.
  - Keep it properly.
  - If you need to transfer the product to a third party, please attach the manual together with the product.
  - Any operation inconsistent with this manual may lead to the damage of the product and personal injury.
- 

## \*Caution

---

- 1.This product can only be dismantled by authorized technician. Such behavior without permission is not suggested.
- 2.Only the power adapter provided by the factory can be used with this product. The use of adapter of other specification may cause damage to the product.
- 3.Don't touch the cord, charging base and power adapter with a wet hand.
- 4.Keep the opening and running parts free of curtain, hair, clothes or finger.
- 5.Don't put the cleaner around burning objects, including cigarette, lighter or anything that is likely to cause fire. Don't use the cleaner to pick up combustible material, including gasoline or toner from printer, copier and mixer. Don't use it with inflammable around.
- 6.Please clean the product after charging, and turn off the product switch before cleaning.
- 7.Do not over-bend wires or place heavy or sharp objects on the machine.
8. This product is an indoor household appliance, please Don't use it outdoors.
9. The cleaner can't be used by children of 8 years and below or persons with mental disorder, unless they have been given supervision or instruction concerning the use of this appliance. Don't let your children ride on or play with the cleaner.
- 10.Do not use this product on wet or watery ground.
- 11.Possible problems in product cleaning shall be eliminated as soon as possible. Please clear up any power cord or small object on the floor before using the cleaner in case they hinder the cleaning. Fold over the fringed hem of carpet and prevent curtain or tablecloth from touching the floor.
12. If the room to be cleaned contains a staircase or any suspended structure, please test first whether the robot will detect it and not fall off the edge. If a physical barrier is needed for protection, make sure the facility does not cause such injury as tripping
13. When the product is not used for a long time, the machine shall be charged every three months to avoid battery failure due to low power for a long time.
- 14.Don't use it without dust bin and filters in place.
- 15.Make sure the power adapter is connected to the socket or charging base when charging.
- 16.Avoid any cold or heat. Operate the robot between -10°C to 50°C.
- 17.Before discarding the product, disconnect the cleaner from charging base, turn off power and remove the battery.
- 18.Make sure the product is not powered on when removing the battery.
19. Please remove and discard the battery in accordance with local laws and regulations before discarding the product.
- 20.Do not use the product with a damaged power cord or power socket. Do not use the product when the product cannot work normally due to falling, damage, outdoor use or water ingress.

## 2.Precautions

Please read the following guidelines before using the Cleaner.

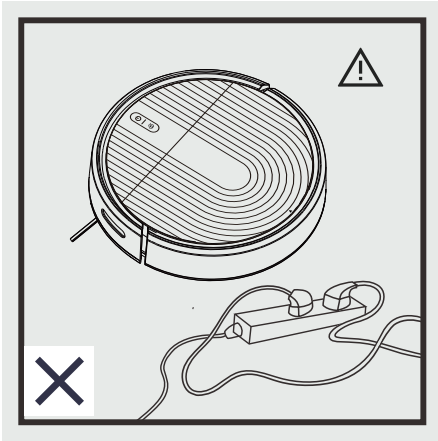

The power cord and other sundries scattered on the ground may entangle or wrap the product. Be sure to remove them before use.

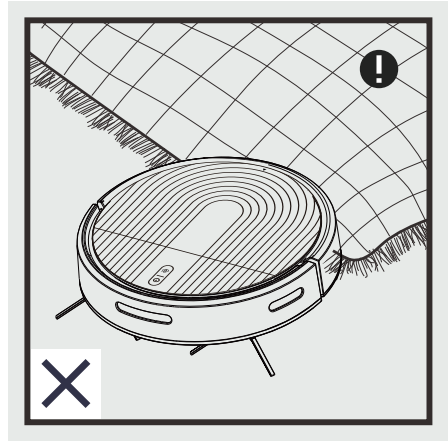

Please roll up the fringe of the carpet or make the product work on the short-wool carpet.

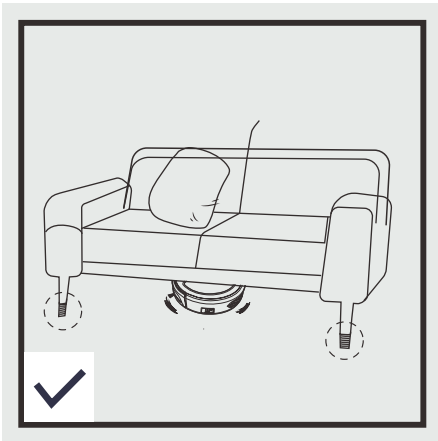

The gap of less than 8cm at the bottom of the household furniture may stick the product. If cleaning is needed, please raise the furniture.

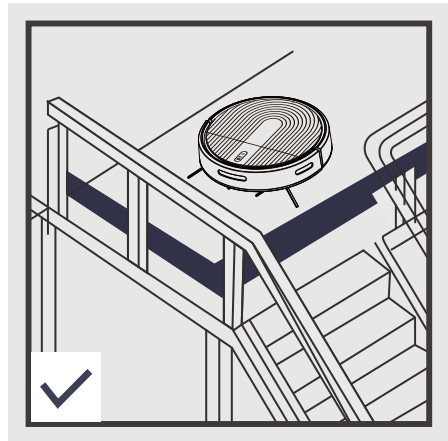

Guardrails shall be placed at the edge of the double layer to ensure the safe operation of the product.

## 3.Product Introduction

### 3.1 Cleaner Part Diagram

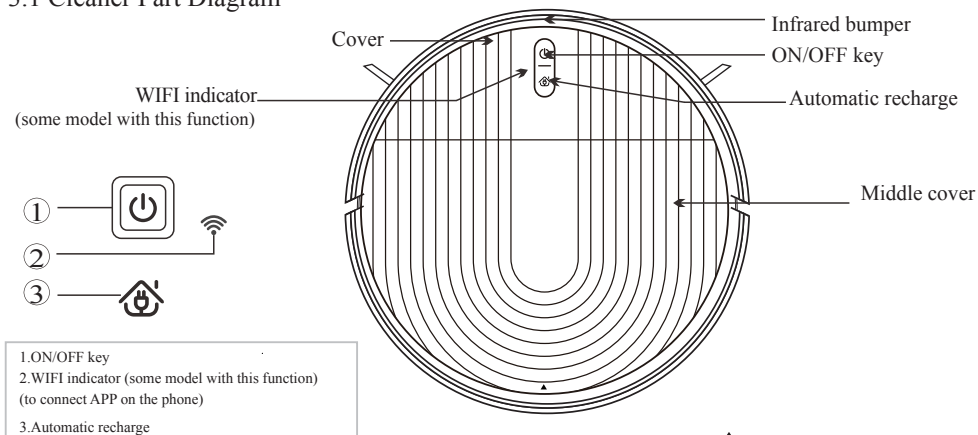

### Main machine

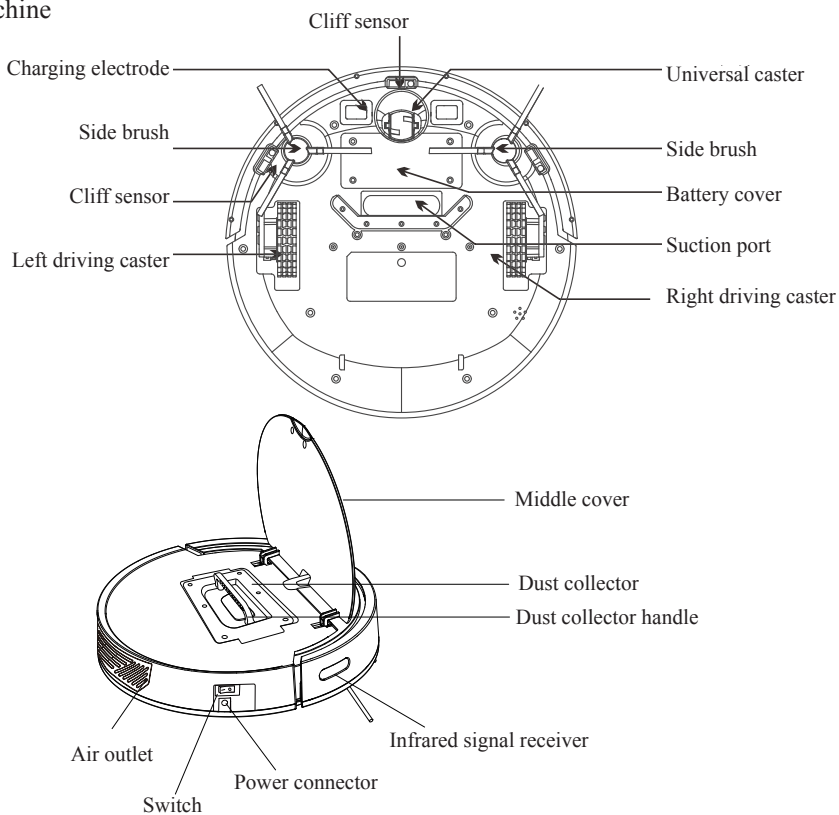

### 3.Product Introduction

#### Function keys



- ON/OFF key
- WIFI indicator (some model with this function)
- Automatic recharge

Indicator status:

- 1.Power on: Green light constantly on
- 2.Abnormal: Red light flashing
- 3.Changing: Red light breathe
- 4.Charging finish: Green light constantly on

#### Dust collector

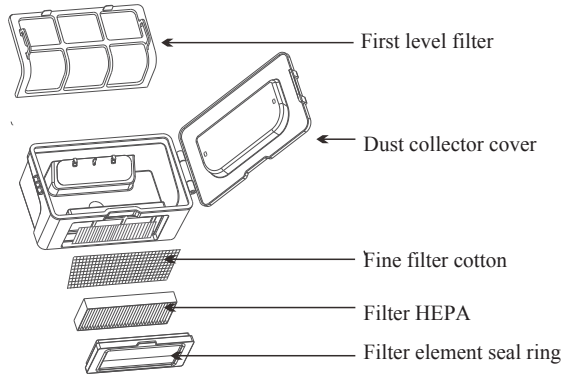

#### Remote controller

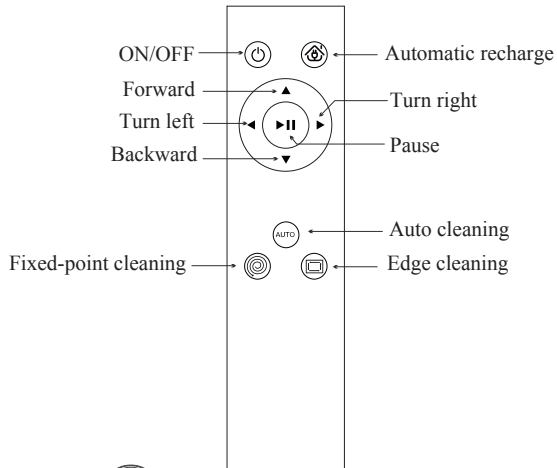

#### Charging base

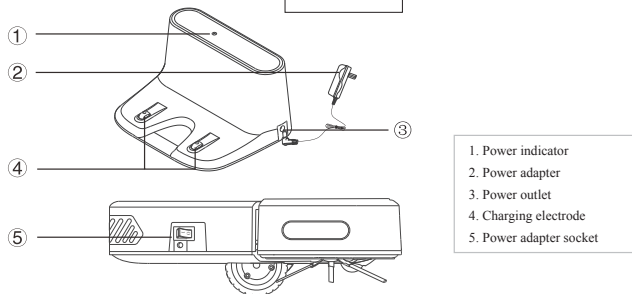

### 3.2 Specifications

Item	Parameters
Diameter	320mm
Height	78mm
Net weight	2kg
Voltage	7.4V
Power	15W
Dust collector volume	600ml
Water tank capacity	200ml
Charging type	Automatic charging / manual charging
Cleaning mode	Automatic cleaning, fixed-point cleaning Edge cleaning
Full charge time	4-6 hours
Working time	About 60-90minutes
Button type	Physical buttons

Operating voltage (V)	7.4v	Rated power (W)	15
Charging dock			
Rated input voltage (V)	12	Rated output current (A)	0.5
Model and parameters of main accessories			
Remote controller model	V3S01	Rated input voltage (V)	3
HNAD120060C1			
Adapter model	100~240V~ 0.5A MAX 50/60Hz	Output	12V

\*For the purpose of continuous improvement, all rights to change and interpret are reserved in terms of technology and design regarding the product.

\*The models only differ slightly in color and appearance without other essential difference.

## 4.Operation Instructions

### 4.1Charging method and quick start guide

#### 1.How to use the charging base

Place the charging base on the flat ground, then connect the power adapter. The power indicator will be constantly on.The indicator light of the charging base will go out during normal charging.

##### \*Notes

Place the charging base on the flat ground, with the back against the wall, and remove all obstacles around the charging base of about 1.5 meter in width and 2 meters in front of the charging base, as shown in the figure.

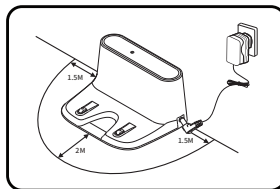

#### 2.Two charging methods

1>Directly plug the power adapter into the machine, with the other end connecting with power Supply,as shown in figure A. Please use the power adapter provided.

2>Use the charging base for charging, as shown in figure B.

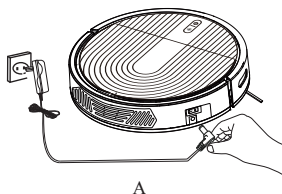

A

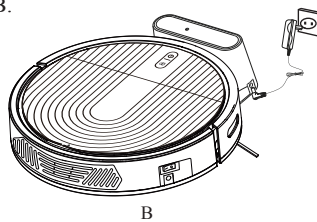

B

##### \*Notes

- A. Please charge the machine for not less than 12 hours when charging for the first time, and charge it until the red light of the power key (⏻) and (🔌) breathe. When the battery is fully filled, the green light will be constantly on.
- B. For daily use, please store the machine on the charging stand and make sure the charging stand is powered on.
- C. When not in use for a long time, please full charge the machine, turn off the power switch and store it in a cool and dry place.
- D. When setting the reservation mode, do not use manual charging mode. It is recommended to use automatic charging mode.

#### 3.Power on

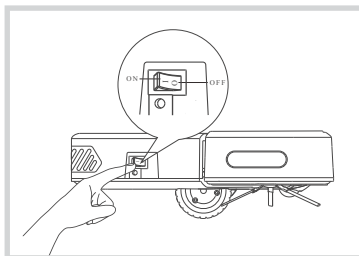

Turn on the power switch, the panel button indicator flashes (1 means power ON, 0 means power OFF)







## 4.2 Remote controller





- 1 Standby 

Press this key to enter the sleep mode; press  key for restarting the machine; If the machine is not operated within 3 minutes, the machine will automatically enter the sleep mode.
- 2 Auto cleaning 

Press this key to start cleaning automatically; Press  to pause the machine if necessary.
- 3 Automatic recharge 

Press this key to automatically find the charging base for charging.
- 4 Pause 

Press this key in the running state of the machine to pause the machine, and press this key in the sleeping state of the machine to wake up.
- 5 Direction
 



<p>A  ” Forward Press this key to move the machine forward.</p>	<p>B  ” Backward Press this key to move the machine back.</p>
<p>C  ” Left Press this key to move the machine left.</p>	<p>D  ” Right Press this key to move the machine right</p>
- 6 Edge cleaning 

Press this key to sweep along the wall edge
- 7 Fixed-point cleaning 

Press this key to start the machine’s spiral point cleaning.

## 4.3 Set reservation (some model with this function)

For facilitating cleaning, the product has the "Reserve cleaning" function. Time setting and reservation setting shall be set through APP on the phone. After successful reservation, the cleaner will clean automatically every day according to the setting time. How to connect the APP please see the instruction in the APP User Guide.

Make sure the green light of  is constantly on and the machine is now awakened. If the machine is not awakened, short press  or the remote controller  key to wake up the cleaner.

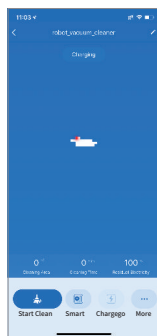

Click "More" in the lower right corner of the APP control interface and select "Schedule"

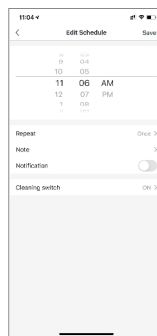

Add and edit Schedule

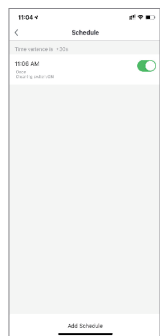

You can cancel the reservation time by closing the item.

## 5.Maintenance

---

### 5.1 Dust collector and filter screen cleaning

Take out the dust collector.

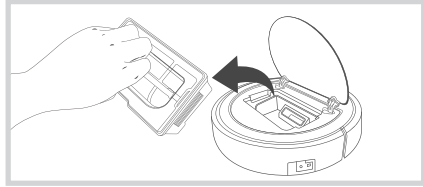

Open the dust collector lock and pour the dust and garbage.

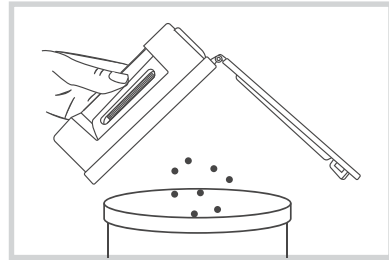
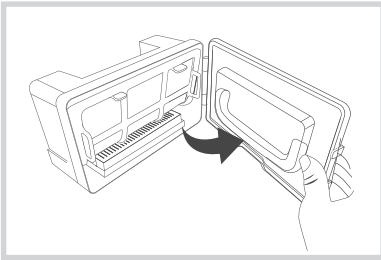

Remove the filter elements. HEPA can be washed with water, and you can tap it to remove dust before washing.

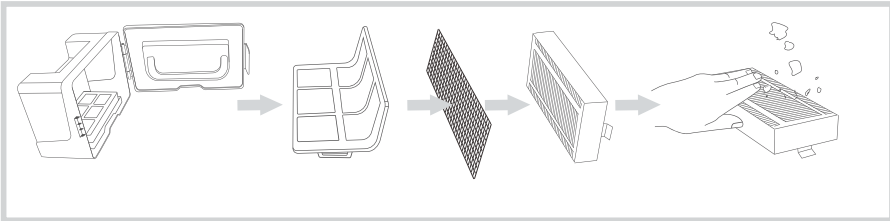

Wash the dust collector and the first filter element, dry the dust collector and filter elements, and keep them dry to ensure their service life

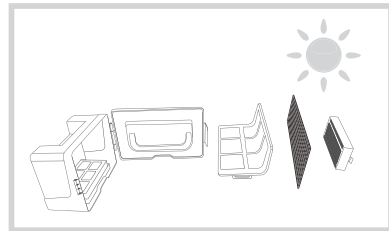
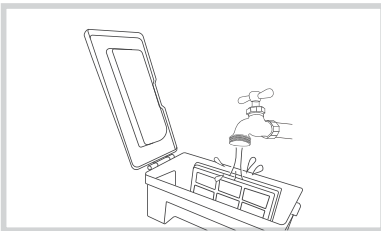

### 5.2 Clean the side brush and universal caster

Clean the side brush

Remove the side brush and wipe it with a clean cloth.

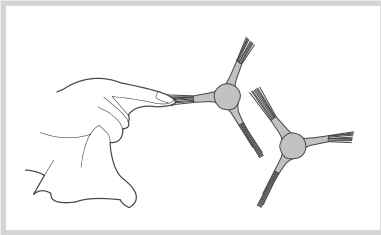

Clean universal caster

Clean the universal caster to remove hair entanglement.

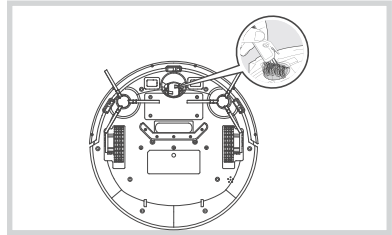

### 5.3 Clean the cliff sensor

Clean the cliff sensor to ensure sensor sensitivity.

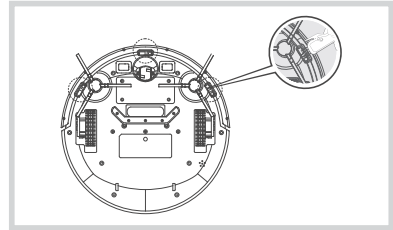

### 5.4 Clean the charging electrode

Gently wipe the bottom of the machine and the charging electrode of the charging base with a soft cloth.

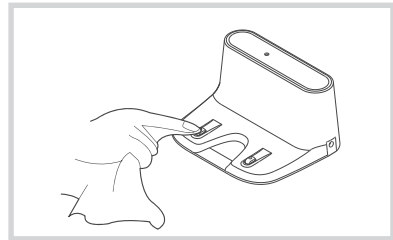
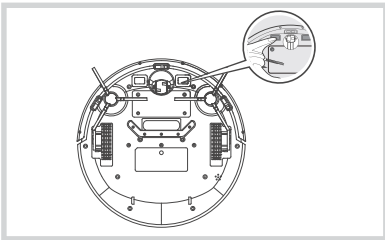

### 5.5 Clean the suction port

If there is a lot of dust in the suction port, please clean it with a cloth.

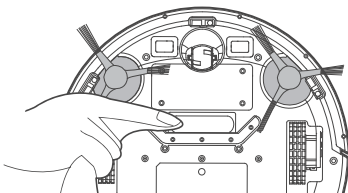

### 5.6 Clean the sensor window

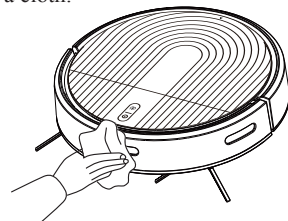

Clean the sensor window

## 5.Maintenance

---

### 5.7 Installation of the water tank(some model with this function)

1. Insert the front end of the water tank into the mop, align as shown in the figure, and paste the mop on the magic tape of the water tank.

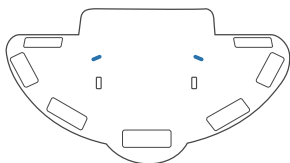

2. Open the inlet on the water tank and slowly inject the water into the water tank.

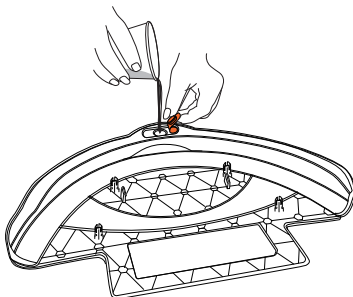

3. Place the bottom of the machine upward, align the positioning column of the water tank with the positioning hole of the carriage at the bottom of the machine, and press the water tank tightly.

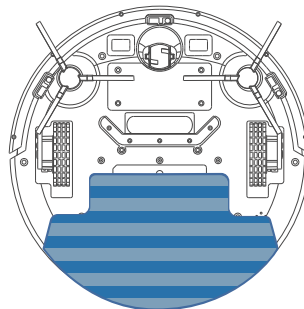
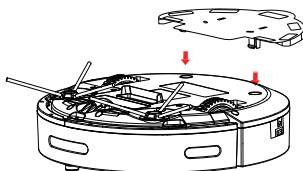

- \*The water tank has no function of closing water seepage, and it will start to seep after water injection. Please remove the water tank before charging.
- \*Pay attention when using the water tank, add water or clean up in time, please remove the tank before adding water.
- \*Please do not use a water seepage tank on the carpet. When using the water tank to mop the floor, please fold up the edge of the carpet, so as to avoid foreign matters on the rag from polluting the carpet.
- \*After cleaning the mop, it is necessary to dry the mop until it does not drip, and then install it on the water tank. At the same time, the mop needs to be flat.

### Indicator description

Robot will emit a series of beeps when it is in trouble, and the red light will flash or keep on.

---

1. Beep once and the red light stays on	Wheel is stuck	please check if there are anything in the wheel gap and clean it up.
2. Beep once and the red light keeps flashing	Front bumper is stuck	please check bumper Whether stuck and clean foreign matter in it.
3. Beeps twice and the red light keeps flashing	Side brush abnormal	please check whether the side brush is entangled with hair and clean it up.
4. Beeps three times and the red light keeps flashing	Ground sensor abnormal	Please check whether the ground sensor is covered by dirt and wipe it clean.
5. Beeps four times and the red light keeps flashing	Power run out	please charge it as soon as possible.

---

Please refer to the maintenance section of the user manual for more information.

#### \*Warm tips

If the above method does not solve the problem, please try the following:

1. Restart the power of the machine.
2. If the problem cannot be solved by restarting the machine, please send the machine to the after-sales service center for maintenance.

## 7.Packing List

Serial number	Description	Quantity
1	Host(include battery)	1
2	Charging base	1
3	Remote controller	1
4	Power adapter	1
5	User manual	1
6	Side brush	1 pair
7	HEPA filter	1
8	Dishcloth	1
9	Water tank (some model include this part)	1

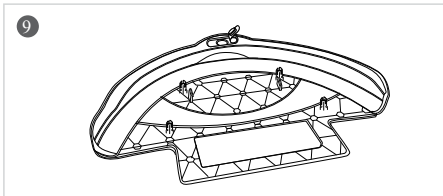
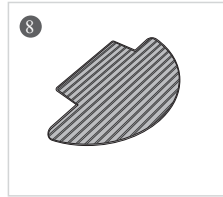
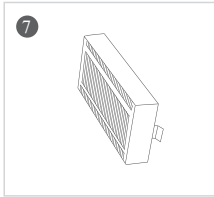
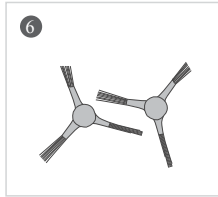
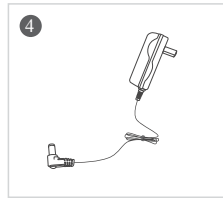
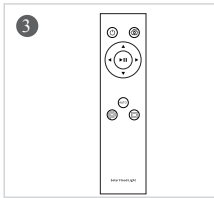
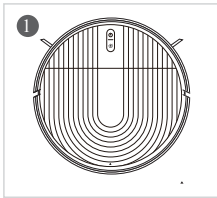



**1141 Budapest, Fogarasi út 77.**

Tel.: \*220-7940, 220-7814, 220-7959,  
220-8881, 364-3428 Fax: 220-7940

Mobil: 30 531-5454, 30 939-9989

**1095 Budapest, Mester utca 34.**

Tel.: \*218-5542, 215-9771, 215-7550,  
216-7017, 216-7018 Fax: 218-5542

Mobil: 30 940-1970, 30 959-0930

**[www.robotol.hu](http://www.robotol.hu)**

**E-mail: [info@delton.hu](mailto:info@delton.hu) Web: [www.delton.hu](http://www.delton.hu)**



"CE" marking states that the product is compliant to European Directives  
2006/95/CE Low Voltage Directive  
2004/108/EC EMC Directive

It is possible to request a full copy of Declaration of compliance to the Distributor:

This product complies with the rules of RoHS Directive(2002/95/CE)

This product complies with the rules of Eup Directive(2009/1255/CE)